



CRDV-C kanałowy



CRDV-R dachowy

ZASTOSOWANIE

Wentylator przeznaczony do transportu medium niezapalnego, zawierającego agresywne związki chemiczne.

Typowe obszary zastosowania:

- dygestoria i laboratoria chemiczne,
- przemysł chemiczny, farmaceutyczny, spożywczy,
- obiekty użyteczności publicznej.

KONSTRUKCJA

- wirnik formowany wtryskowo z trudnopalnego polipropylenu PPS z łopatkami pochylonymi do przodu,
- obudowa formowana termicznie z trudnopalnego polipropylenu PPS,
- płyta montażowa silnika z blachy stalowej nierdzewnej 1.4301,
- montaż w pozycji pionowej lub poziomej,
- maksymalna temperatura tłoczonego medium 60°C,
- temperatura otoczenia silnika od -20°C do +40°C.

SILNIK ELEKTRYCZNY

- asynchroniczny, jednofazowy 230V, 50Hz,
- asynchroniczny, trójfazowy 230/400V 50Hz lub 400V 50Hz,
- stopień ochrony IP55,
- klasa izolacji F,
- do regulacji częstotliwościowej (silniki trójfazowe),
- do regulacji napięciowej (silniki jednofazowe).

WYKONANIA SPECJALNE

- wersja ATEX – patrz wentylatory przeciwwybuchowe,
- silnik na inne niż standardowe napięcie oraz częstotliwość zasilania,
- silnik o innym stopniu ochrony IP,
- silnik wyposażony w czujniki.

DANE TECHNICZNE

Typ	wydajność max	ciśnienie max	moc silnika	prędkość obrotowa	natężenie 230V I 400V	napięcie	poziom. ciśn. akust.	kon- den- sator	masa	regulator	nr artykułu		
	[m³/h]	[Pa]	[kW]	[obr/min]	[A]	[V]	[dB(A)]	[µF]	[kg]		CRDV-C	CRDV-R	
JEDNOFAZOWE													
CRDV 200/180/900S RU	585	70	0,18	900	1,6	-	230	45	20	18	TLR 25 / RVS 3	44012120	44013120
CRDV 200/180/1400S RU	870	185	0,25	1400	1,8	-	230	54	30	18	TLR 25 / RVS 3	44012140	44013140
CRDV 200/180/2800S RU	1745	820	1,1	2800	7,25	-	230	69	90	25	REB 10 / RVS 10	44012160	44013160
CRDV 200/200/900S RU	1070	102	0,18	900	1,6	-	230	46	20	18	TLR 25 / RVS 3	44012220	44013220
CRDV 200/200/1400S RU	1595	260	0,25	1400	1,8	-	230	55	30	18	TLR 25 / RVS 3	44012240	44013240
CRDV 200/200/2800S RU	3200	1075	1,5	2800	10,1	-	230	70	40	28	RVS 14	44012260	44013260
CRDV 250/225/900S RU	1310	135	0,25	900	2,4	-	230	48	25	21	TLR 25 / RVS 3	44012320	44013320
CRDV 250/225/1400S RU	1950	325	0,55	1400	3,8	-	230	57	60	23	REB 5 / RVS 5	44012340	44013340
CRDV 250/250/900S RU	2000	185	0,25	900	2,4	-	230	52	25	21	TLR 25 / RVS 3	44012420	44013420
CRDV 250/250/1400S RU	2990	415	0,75	1400	5	-	230	61	80	27	REB 10 / RVS 7	44012440	44013440
CRDV 315/280/900S RU	2400	230	0,55	900	3,8	-	230	56	60	29	REB 5 / RVS 5	44012520	44013520
CRDV 315/280/1400S RU	3600	540	1,1	1400	7,75	-	230	65	110	32	REB 10 / RVS 10	44012540	44013540
CRDV 315/315/900S RU	3300	255	0,75	900	5,2	-	230	60	75	32	REB 10 / RVS 7	44012620	44013620
TRÓJFAZOWE													
CRDV 200/180/900T	585	70	0,18	900	1,3	0,75	230/400	45	-	17	Falownik 0.4kW	44012110	44013110
CRDV 200/180/1400T	870	185	0,25	1400	1,5	0,85	230/400	54	-	17	Falownik 0.4kW	44012130	44013130
CRDV 200/180/2800T	1745	820	1,1	2800	4,3	2,5	230/400	69	-	22	Falownik 1.5kW	434012150	434013150
CRDV 200/180/1400/900T	870/585	185/70	0,25/0,18	1400/900	0,7	0,9	230/400	54/45	-	18	-	44012170	44013170
CRDV 200/180/2800/1400T	1745/870	820/185	1,4/0,33	2800/1400	0,9	3,3	230/400	69/54	-	24	-	44012180	44013180
CRDV 200/200/900T	1070	112	0,18	900	1,3	0,75	230/400	46	-	17	Falownik 0.4kW	44012210	44013210
CRDV 200/200/1400T	1595	260	0,25	1400	1,5	0,85	230/400	55	-	17	Falownik 0.4kW	44012230	44013230
CRDV 200/200/2800T	3200	1075	1,5	2800	5,25	3	230/400	70	-	29	Falownik 1.5kW	434012250	434013250
CRDV 200/200/1400/900T	1595/1070	260/112	0,25/0,18	1400/900	0,7	0,9	230/400	55/46	-	18	-	44012270	44013270
CRDV 200/200/2800/1400T	3200/1595	1075/260	2,0/0,5	2800/1400	1,2	4,3	230/400	70/55	-	30	-	44012280	44013280
CRDV 250/225/900T	1310	135	0,18	900	1,3	0,75	230/400	48	-	19	Falownik 0.4kW	44012310	44013310
CRDV 250/225/1400T	1950	325	0,55	1400	2,8	1,6	230/400	57	-	26	Falownik 0.75kW	44012330	44013330
CRDV 250/225/2800T	3920	1330	3	2800	9,3	5,3	230/400	72	-	37	Falownik 2.2kW	434012350	434013350
CRDV 250/225/1400/900T	1950/1310	325/135	0,75/0,25	1400/900	1,28	1,98	230/400	57/48	-	23	-	44012360	44013360
CRDV 250/225/2800/1400T	3920/1950	1330/325	3,3/0,85	2800/1400	1,9	6,7	230/400	72/57	-	38	-	44012370	44013370
CRDV 250/250/900T	2000	185	0,18	900	1,3	0,75	230/400	52	-	19	Falownik 0.4kW	44012410	44013410
CRDV 250/250/1400T	2990	415	0,75	1400	3,6	2,1	230/400	61	-	24	Falownik 0.75kW	434012430	434013430
CRDV 250/250/1400/900T	2990/2000	415/185	0,75/0,25	1400/900	1,28	1,98	230/400	61/52	-	22	-	44012450	44013450
CRDV 315/280/900T	2400	230	0,37	900	2,4	1,4	230/400	56	-	25	Falownik 0.4kW	44012510	44013510
CRDV 315/280/1400T	3600	540	1,1	1400	4,3	2,5	230/400	65	-	30	Falownik 1.5kW	434012530	434013530
CRDV 315/280/1400/900T	3600/2400	540/230	1,1/0,37	1400/900	1,1	2,9	230/400	65/56	-	40	-	44012550	44013550
CRDV 315/315/900T	3300	255	0,55	900	3,1	1,8	230/400	60	-	26	Falownik 0.75kW	44012610	44013610
CRDV 315/315/1400T	4925	605	2,2	1400	8,1	4,6	230/400	69	-	40	Falownik 2.2kW	424012630*	424013630*
CRDV 315/315/1400/900T	4925/3300	605/255	2,2/0,75	1400/900	2,55	5,18	230/400	69/60	-	43	-	44012640	44013640

* konieczność zasilania przez falownik.

CHARAKTERYSTYKI PRACY

Minimalna prędkość przepływu powietrza 3 m/s.

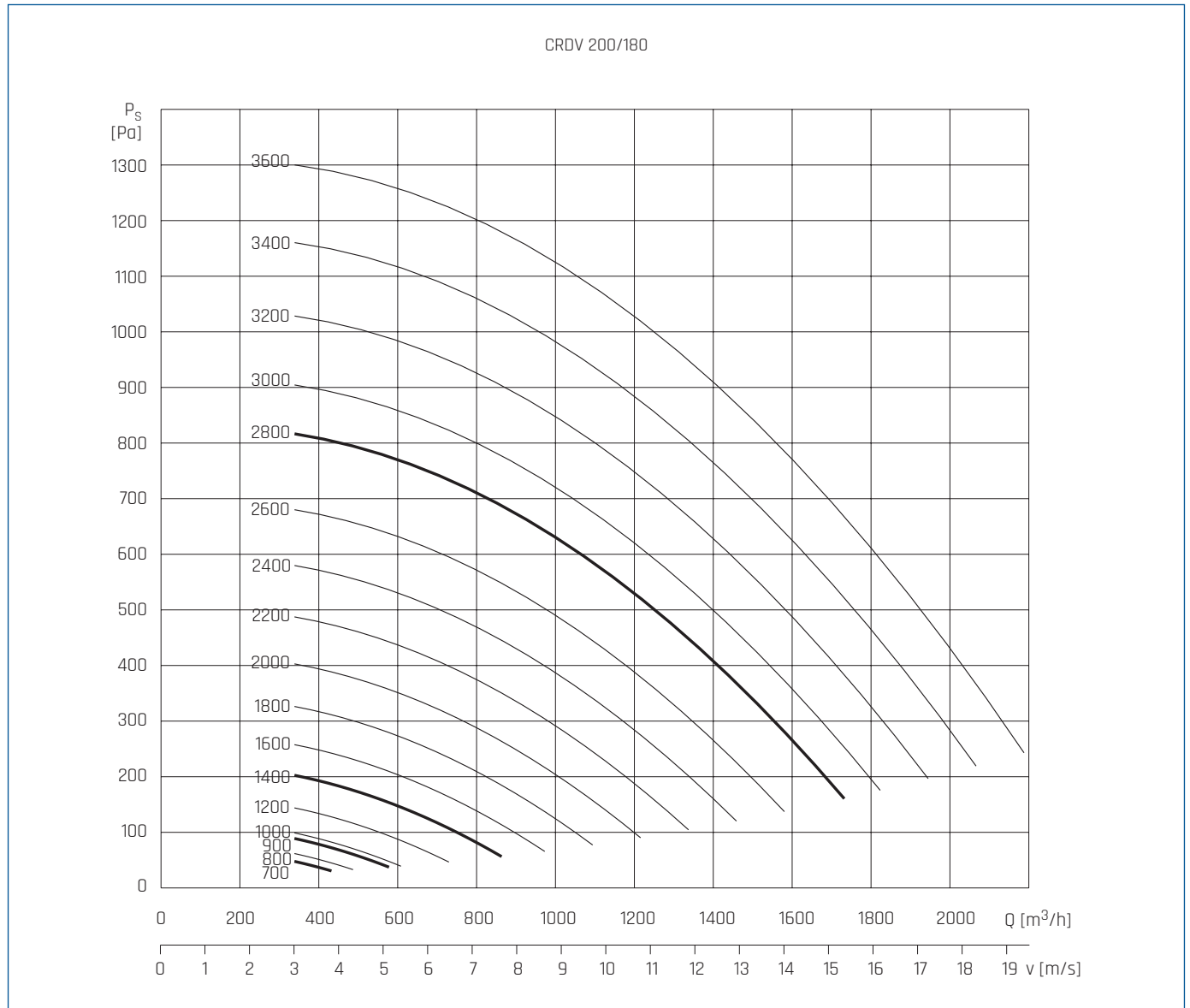

Poziom mocy akustycznej L_{WA} [dB(A)], Poziom ciśnienia akustycznego $L_{PA} = L_{WA} - 7$ dB(A), Odległość 1m.

n [obr/min]	L_{WA} [dB(A)]	Hz							
		63	125	250	500	1000	2000	4000	8000
700	46	20	32	40	43	39	35	28	19
850	51	25	37	45	48	44	40	33	24
900	52	26	38	46	49	45	41	34	25
1100	56	30	42	50	53	49	45	38	29
1400	61	35	47	55	58	54	50	43	34
1700	65	39	51	59	62	58	54	47	38
2800	76	50	62	70	73	69	65	58	49

CHARAKTERYSTYKI PRACY

Minimalna prędkość przepływu powietrza 3 m/s.

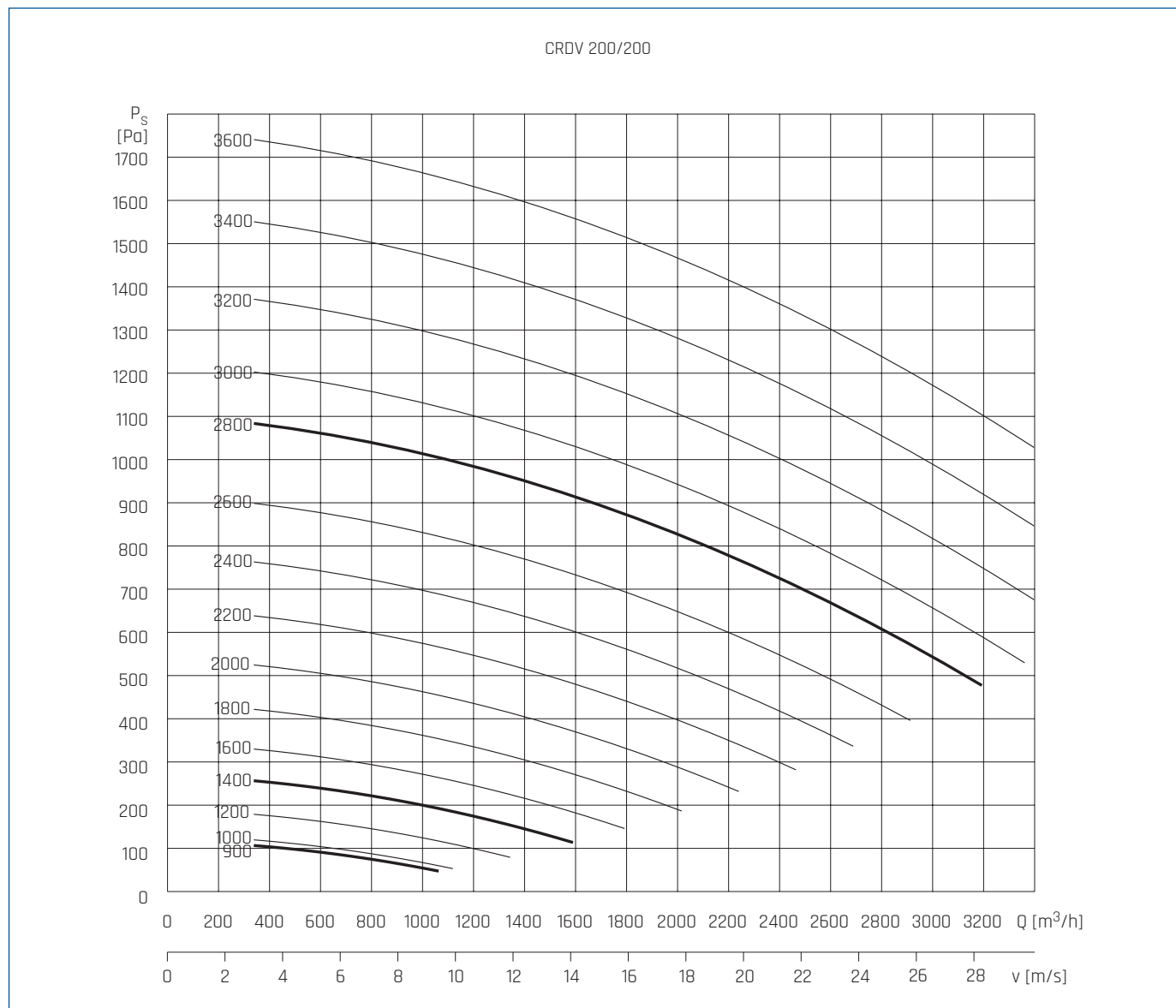

Poziomość mocy akustycznej L_{WA} [dB(A)], Poziomość ciśnienia akustycznego $L_{PA} = L_{WA} - 7$ dB(A), Odległość 1m.

n [obr/min]	L_{WA} [dB(A)]	Hz							
		63	125	250	500	1000	2000	4000	8000
700	47	11	33	39	40	42	39	30	21
850	52	16	38	44	45	47	44	35	26
900	53	17	39	45	46	48	45	36	27
1100	57	21	43	49	50	52	49	40	31
1400	62	26	48	54	55	57	54	45	36
1700	66	30	52	58	59	61	58	49	40
2800	77	41	63	69	70	72	69	60	51

CHARAKTERYSTYKI PRACY

Minimalna prędkość przepływu powietrza 3 m/s.

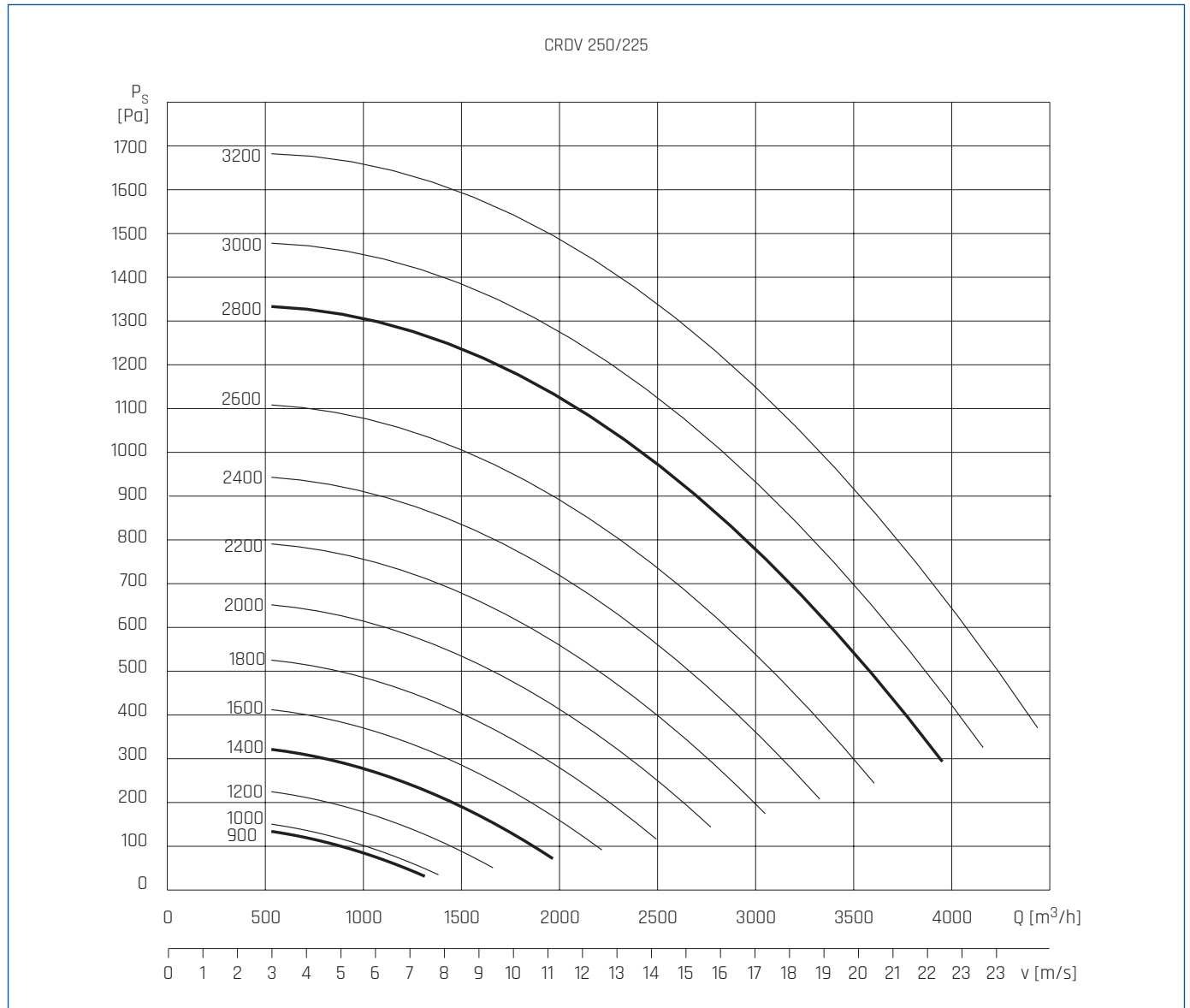

Poziom mocy akustycznej L_{WA} [dB(A)]. Poziom ciśnienia akustycznego $L_{PA} = L_{WA} - 7$ dB(A). Odległość 1m.

n [obr/min]	L_{WA} [dB(A)]	Hz							
		63	125	250	500	1000	2000	4000	8000
700	49	18	32	41	44	45	42	33	23
850	54	23	37	46	49	50	47	38	28
900	55	24	38	47	50	51	48	39	29
1100	59	28	42	51	54	55	52	43	33
1400	64	33	47	56	59	60	57	48	38
1700	68	37	51	60	63	64	61	52	42
2800	79	48	62	71	74	75	72	63	53

CHARAKTERYSTYKI PRACY

Minimalna prędkość przepływu powietrza 3 m/s.

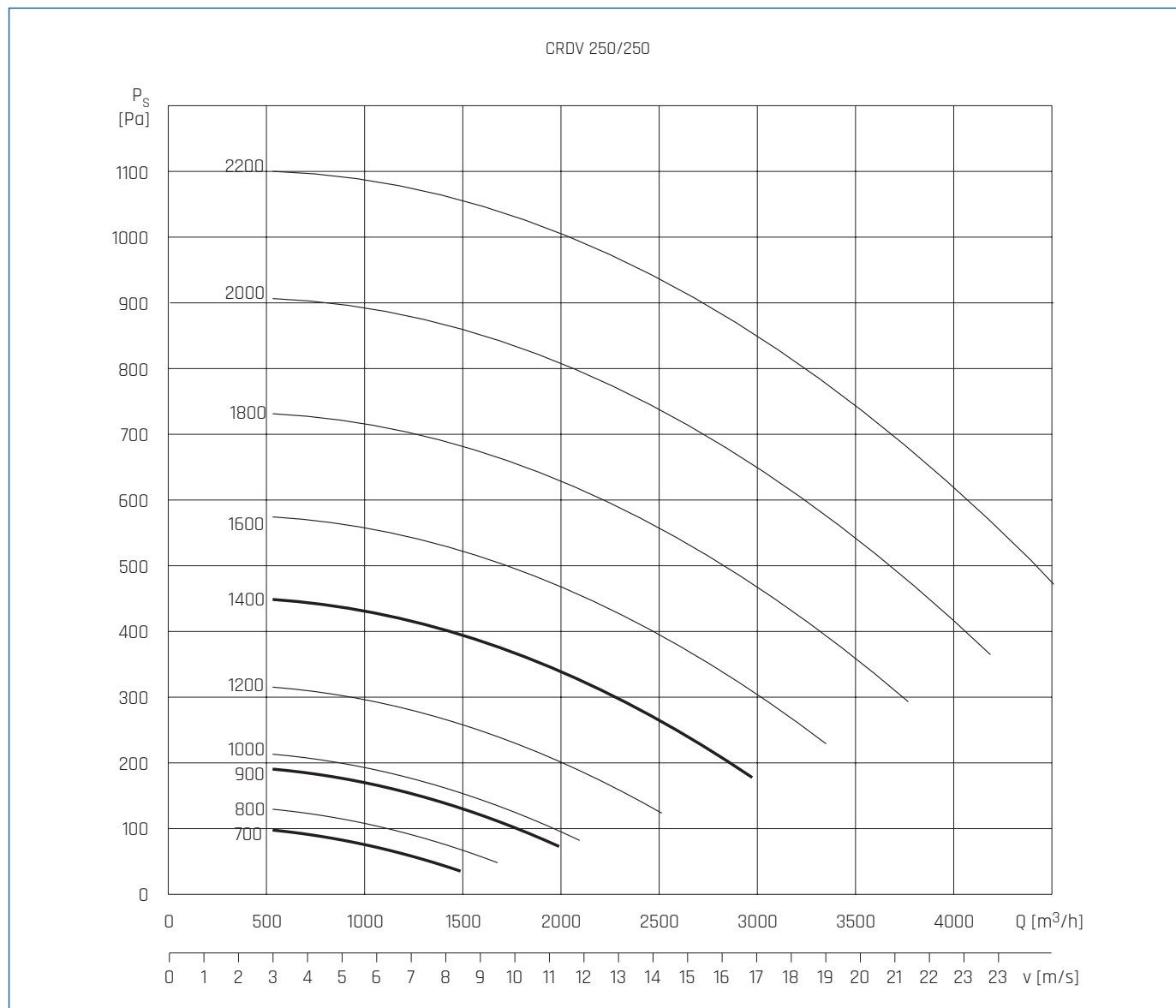

Poziom mocy akustycznej L_{WA} [dB(A)], Poziom ciśnienia akustycznego $L_{PA} = L_{WA} - 7$ dB(A), Odległość 1m.

n [obr/min]	L_{WA} [dB(A)]	Hz							
		63	125	250	500	1000	2000	4000	8000
700	53	22	38	46	48	49	44	36	26
850	58	27	43	51	53	54	49	41	31
900	59	28	44	52	54	55	50	42	32
1100	63	32	48	56	58	59	54	46	36
1400	68	37	53	61	63	64	59	51	41

CHARAKTERYSTYKI PRACY

Minimalna prędkość przepływu powietrza 3 m/s.

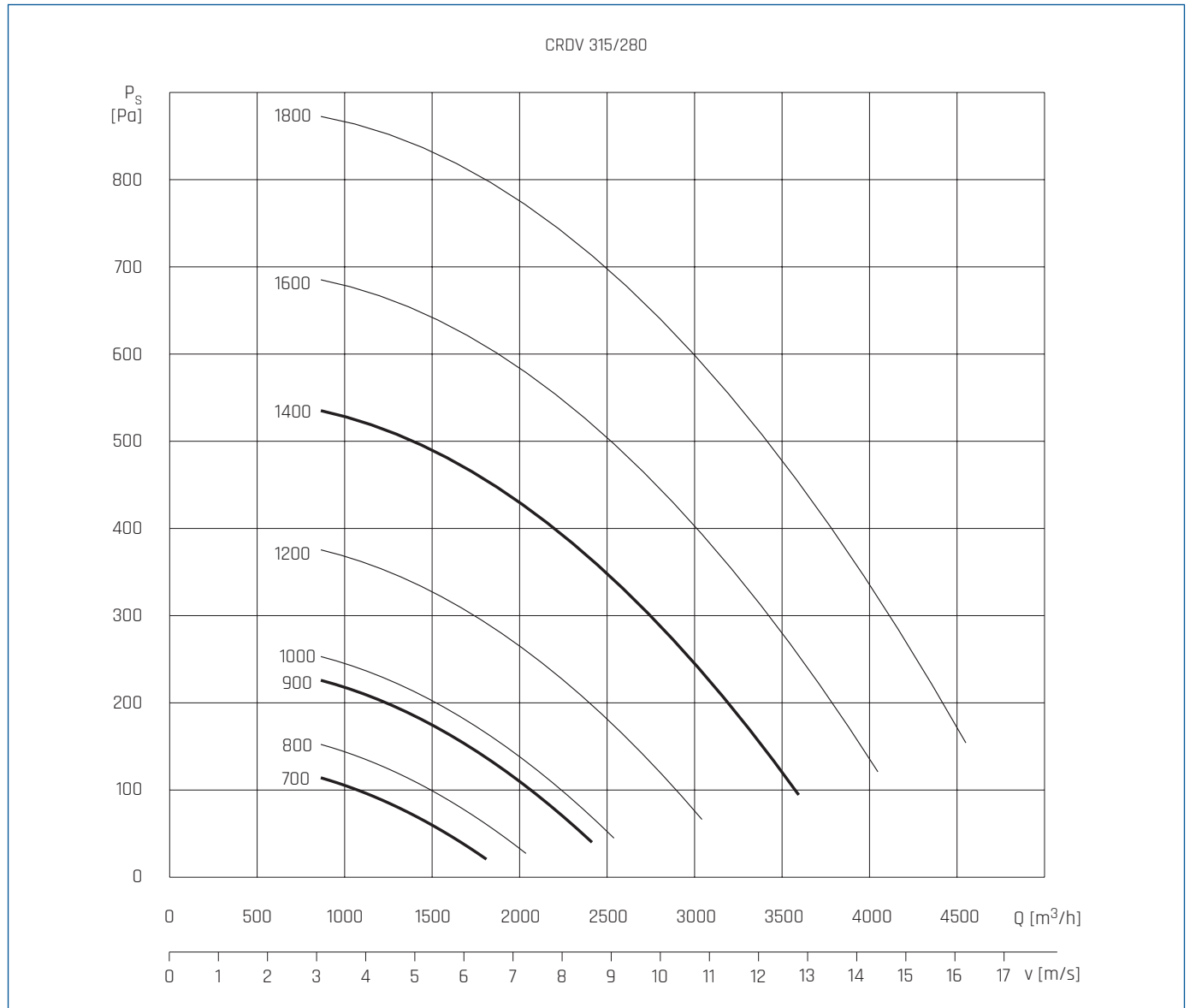

Poziom mocy akustycznej L_{WA} [dB(A)], Poziom ciśnienia akustycznego $L_{PA} = L_{WA} - 7$ dB(A), Odległość 1m.

n [obr/min]	L_{WA} [dB(A)]	Hz							
		63	125	250	500	1000	2000	4000	8000
700	57	33	42	49	52	52	48	40	31
850	62	38	47	54	57	57	53	45	36
900	63	39	48	55	58	58	54	46	37
1100	67	43	52	59	62	62	58	50	41
1400	72	48	57	64	67	67	63	55	46

CHARAKTERYSTYKI PRACY

Minimalna prędkość przepływu powietrza 3 m/s.

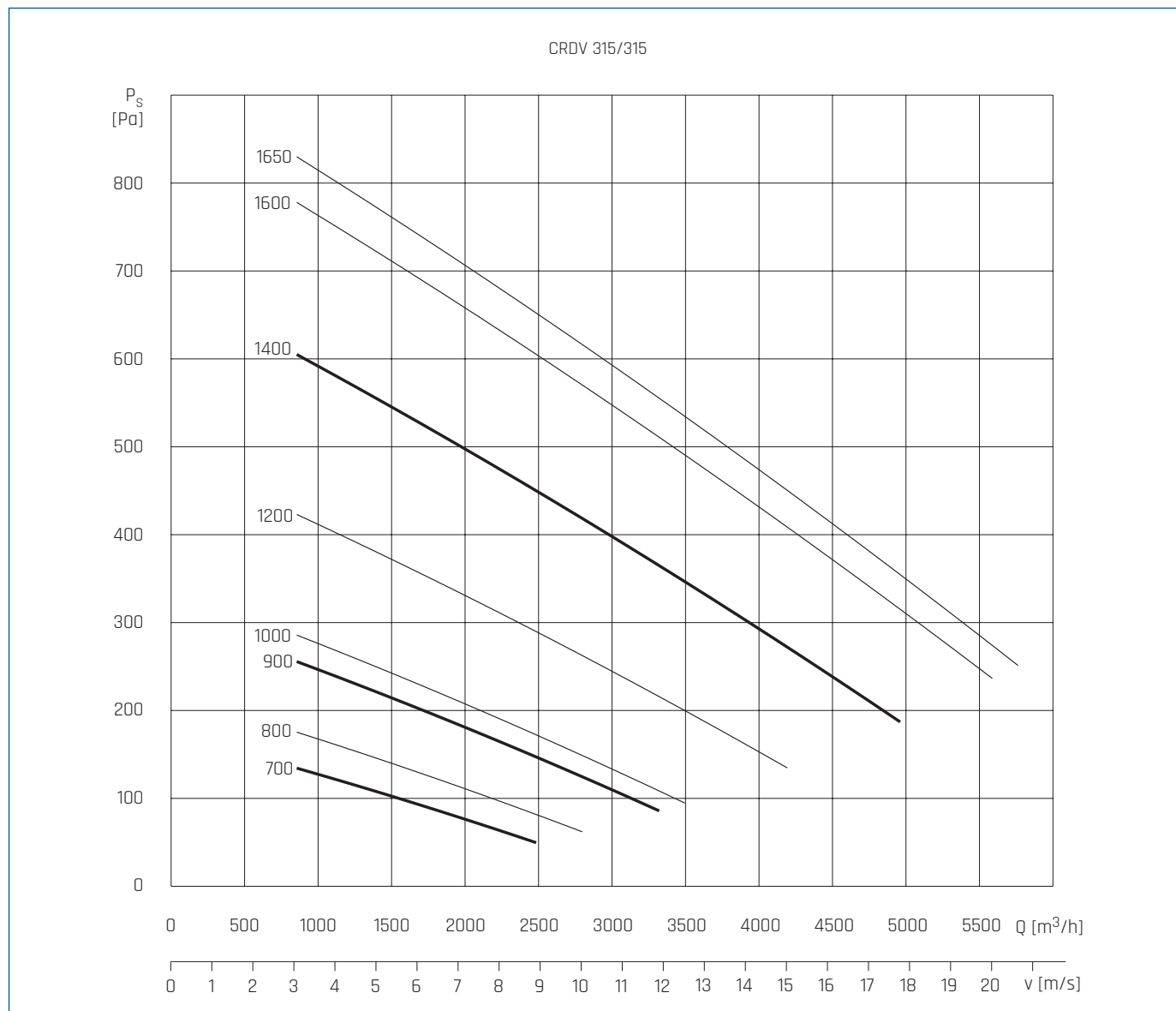

Poziom mocy akustycznej L_{WA} [dB(A)], Poziom ciśnienia akustycznego $L_{PA} = L_{WA} - 7$ dB(A), Odległość 1m.

n [obr/min]	L_{WA} [dB(A)]	Hz							
		63	125	250	500	1000	2000	4000	8000
700	61	30	44	57	53	56	52	45	34
850	66	35	49	62	58	61	57	50	39
900	67	36	50	63	59	62	58	51	40
1100	71	40	54	67	63	66	62	55	44
1400	76	45	59	72	68	71	67	60	49

WYMIARY [mm]

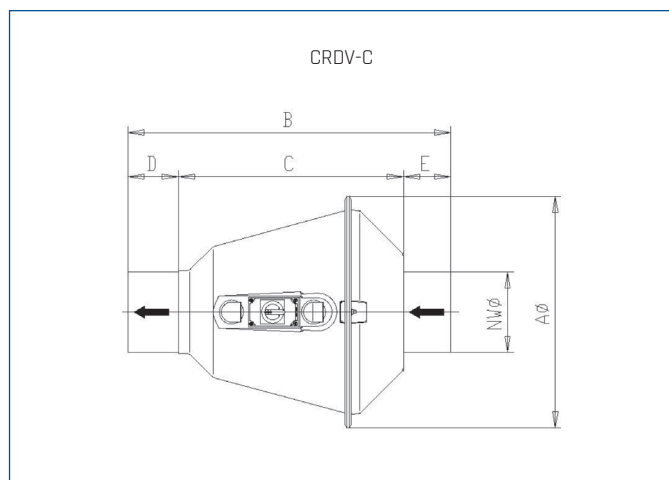

Typ	NWØ	AØ	B	C	D	E
200	200	576	800	558	125	117
250	250	636	905	573	170	162
315	315	706	1031	599	220	212

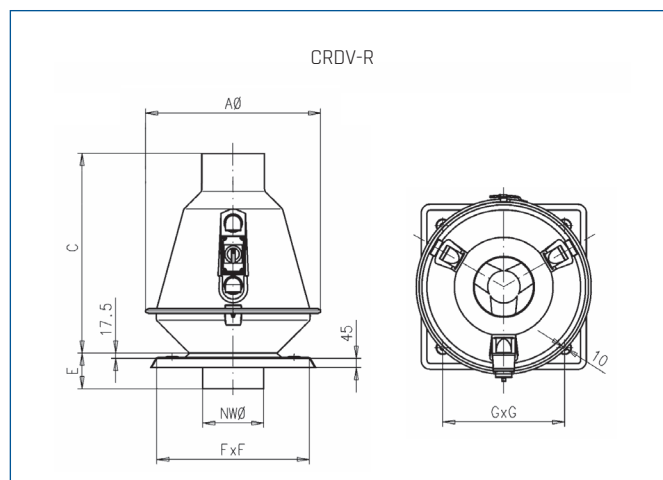

Typ	NWØ	AØ	C	E	FxF	GxG
200	200	576	683	117	495	400
250	250	636	743	162	535	435
315	315	706	819	212	645	520

AKCESORIA MONTAŻOWE

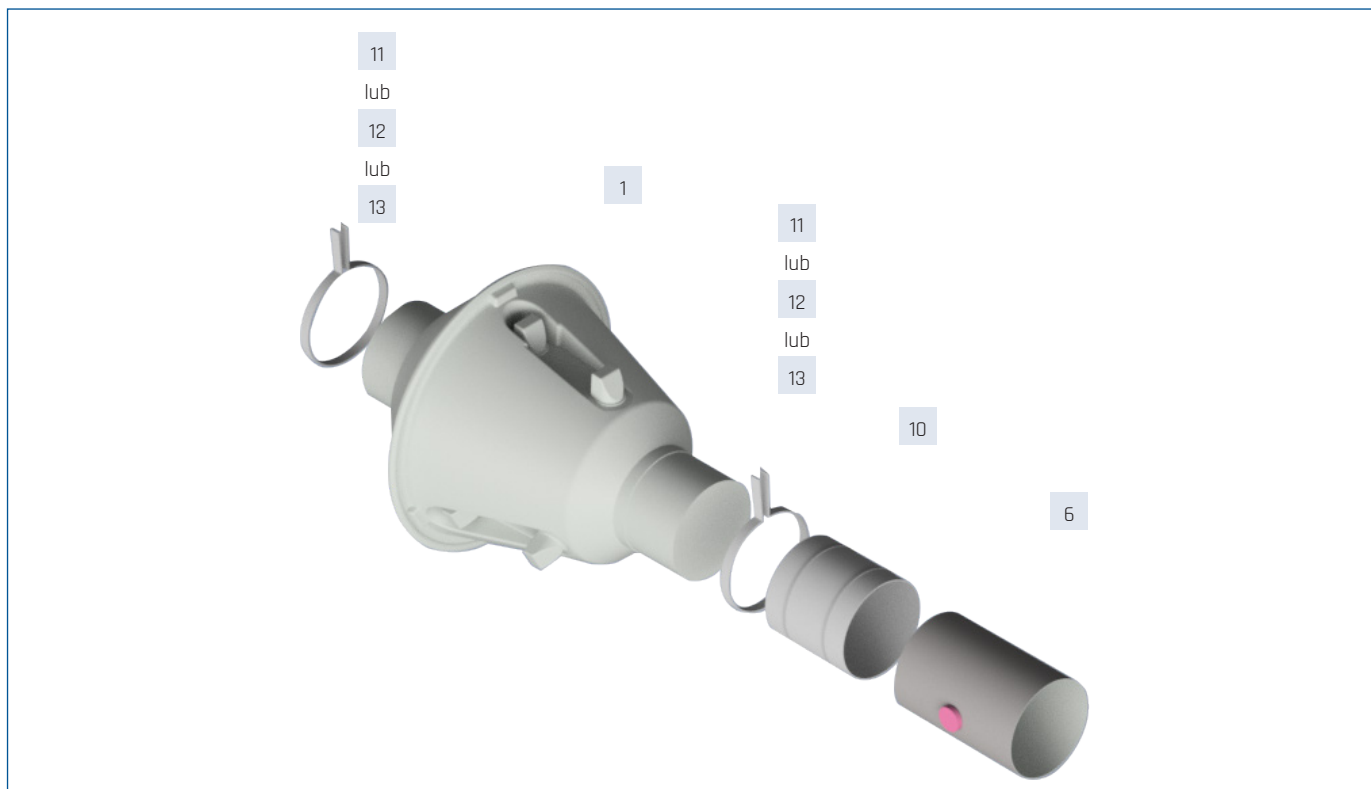
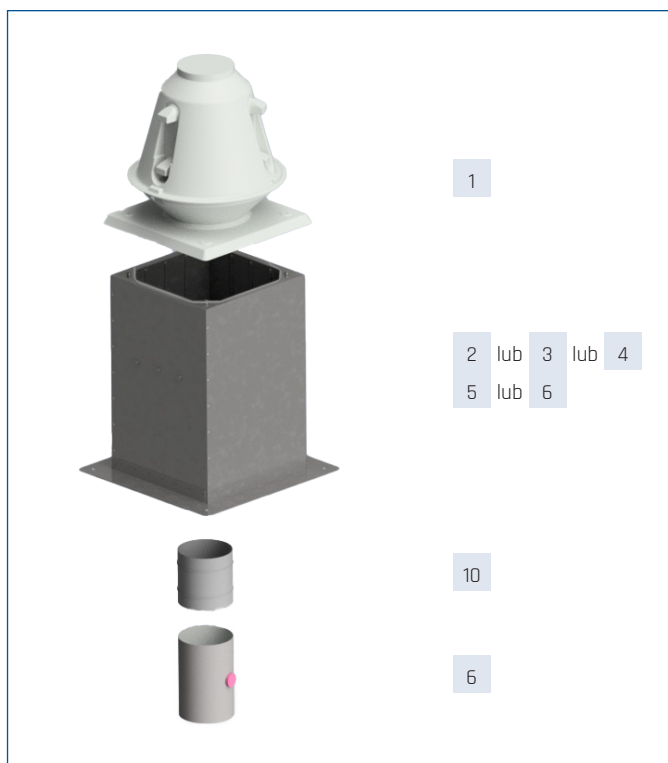

AKCESORIA MONTAŻOWE

1 Wentylator	2		3		4		5 podstawa dachowa typ E	6 podstawa dachowa typ R	7	
	podstawa dachowa RS		podstawa dachowa RS-I		podstawa dachowa RS-RI				złącze P	
	GALV	AP	GALV	AP	GALV	AP			GALV	AP
CRDV 200	RS 495	RS 495 AP	RS-I 495	RS-I 495 AP	RS-RI 495	RS-RI 495 AP	CRDV 200E	CRDV 200R	P-495	P-495 AP
CRDV 250	RS 535	RS 535 AP	RS-I 535	RS-I 535 AP	RS-RI 535	RS-RI 535 AP	CRDV 250E	CRDV 250R	P-535	P-535 AP
CRDV 315	RS 645	RS 635 AP	RS-I 635	RS-I 635 AP	RS-RI 635	RS-RI 635 AP	CRDV 315E	CRDV 315R	P-635	P-635 AP

1 Wentylator	8		9 złącze przeciwdrganiowe	10 klapa zwrotna	11 wspornik ścienny do montażu pionowego	12 wspornik ścienny do montażu poziomego	13 wspornik ścienny do montażu sufitowego lub podłóg
	króciec K						
	GALV	AP					
CRDV 200	K-495	K-495 AP	ZP CRDV200	ZP CRDV200	ZP CRDV200	ZP CRDV200	ZP CRDV200
CRDV 250	K-535	K-535 AP	ZP CRDV250	ZP CRDV250	ZP CRDV250	ZP CRDV250	ZP CRDV250
CRDV 315	K-635	K-635 AP	ZP CRDV315	ZP CRDV315	ZP CRDV315	ZP CRDV315	ZP CRDV315



Numery artykułów

RS 495	43526930-02	RS-RI 535 AP	43526940-07	P-635	43526331	KZ CRDV200	44025530	WV CRDV 315	44025503
RS 495 AP	43526930	RS 635	43526950-02	P-635 AP	43526331-01	KZ CRDV250	44025531	WH CRDV 200	44025500
RS-I 495	43526930-03	RS 635 AP	43526950	K-495	43526418	KZ CRDV 315	44025532	WH CRDV 250	44025504
RS-I 495 AP	43526930-01	RS-I 635	43526950-03	K-495 AP	43526418-01	CRDV 200E	44025540	WH CRDV 315	44025502
RS-RI 495	43526930-06	RS-I 635 AP	43526950-01	K-535	43526419	CRDV 250E	44025542	WF CRDV 200	44025507
RS-RI 495 AP	43526930-07	RS-RI 635	43526950-04	K-535 AP	43526419-01	CRDV 315E	44025543	WF CRDV 250	44025506
RS 535	43526940-02	RS-RI 635 AP	43526950-05	K-635	43526433	CRDV 200R	44025545	WF CRDV 315	44025508
RS 535 AP	43526940	P-495	43526318	K-635 AP	43526433-01	CRDV 250R	44025546		
RS-I 535	43526940-03	P-495 AP	43526318-01	ZP CRDV200	44025564	CRDV 315R	44025547		
RS-I 535 AP	43526940-01	P-535	43526319	ZP CRDV250	44025566	WV CRDV 200	44025505		
RS-RI 535	43526940-06	P-535 AP	43526319-01	ZP CRDV315	44025567	WV CRDV 250	44025504		

AKCESORIA ELEKTRYCZNE

Wentylator	regulator tyrystorowy			regulator transformatorowy		regulator transformatorowy 2-nastawowy		11-stopn. regulator tyrystorowy	2-nastaw. 6-biegowy regulator tyrystorowy	ERV	rozłącznik serwisowy
	REB N	REB NE	TLR	RMB	RVS	SC2	SC2A				
CRDV 200/180/900S RU	REB-2.5 N	REB-2.5 NE	TLR 25 DS	RMB-3.5	RVS-3	SC2-1-25L25	SC2A1-25L25	IRF-900	RND-1	ERV-3	R-S 1-F+SP, 10A
CRDV 200/180/1400S RU	REB-2.5 N	REB-2.5 NE	TLR 25 DS	RMB-3.5	RVS-3	SC2-1-25L25	SC2A1-25L25	IRF-900	RND-1	ERV-3	R-S 1-F+SP, 10A
CRDV 200/180/2800S RU	REB-10	-	-	RMB-8	RVS-10	SC2-1-75L25	SC2A1-75L25	-	-	ERV-10	R-S 1-F+SP, 10A
CRDV 200/200/900S RU	REB-2.5 N	REB-2.5 NE	TLR 25 DS	RMB-3.5	RVS-3	SC2-1-25L25	SC2A1-25L25	IRF-900	RND-1	ERV-3	R-S 1-F+SP, 10A
CRDV 200/200/1400S RU	REB-2.5 N	REB-2.5 NE	TLR 25 DS	RMB-3.5	RVS-3	SC2-1-25L25	SC2A1-25L25	IRF-900	RND-1	ERV-3	R-S 1-F+SP, 10A
CRDV 200/200/2800S RU	-	-	-	-	RVS-14	SC2-1-110L25	SC2A1-110L25	-	-	-	R-S 1-F, 16A
CRDV 250/225/900S RU	REB-2.5 N	REB-2.5 NE	TLR 25 DS	RMB-3.5	RVS-3	SC2-1-25L25	SC2A1-25L25	IRF-900	RND-1	ERV-3	R-S 1-F+SP, 10A
CRDV 250/225/1400S RU	REB-5	-	-	RMB-8	RVS-5	SC2-1-50L25	SC2A1-50L25	IRF-900	ERV-5	ERV-5	R-S 1-F+SP, 10A
CRDV 250/250/900S RU	REB-2.5 N	REB-2.5 NE	TLR 25 DS	RMB-3.5	RVS-3	SC2-1-25L25	SC2A1-25L25	IRF-900	RND-1	ERV-3	R-S 1-F+SP, 10A
CRDV 250/250/1400S RU	REB-10	-	-	RMB-8	RVS-7	SC2-1-75L25	SC2A1-75L25	-	-	ERV-10	R-S 1-F+SP, 10A
CRDV 315/280/900S RU	REB-5	-	-	RMB-8	RVS-5	SC2-1-50L25	SC2A1-50L25	IRF-900	ERV-5	ERV-5	R-S 1-F+SP, 10A
CRDV 315/280/1400S RU	REB-10	-	-	RMB-8	RVS-10	SC2-1-110L25	SC2A1-110L25	-	-	ERV-10	R-S 1-F+SP, 10A
CRDV 315/315/900S RU	REB-10	-	-	RMB-8	RVS-7	SC2-1-75L25	SC2A1-75L25	-	-	ERV-10	R-S 1-F+SP, 10A

AKCESORIA ELEKTRYCZNE

Wentylator	przełącznik biegów	falownik	rozłącznik serwisowy
CRDV 200/180/900T	-	L 0,4kW	R-S 3-F + SP, 10A
CRDV 200/180/1400T	-	L 0,4kW	R-S 3-F + SP, 10A
CRDV 200/180/2800T	-	L 1.5kW	R-S 3-F + SP, 10A
CRDV 200/180/1400/900T	0-Y-Y	-	R-S 3-F + SP, 10A
CRDV 200/180/2800/1400T	0-Y-YY 10A IP55	-	R-S 3-F + SP, 10A
CRDV 200/200/900T	-	L 0,4kW	R-S 3-F + SP, 10A
CRDV 200/200/1400T	-	L 0,4kW	R-S 3-F + SP, 10A
CRDV 200/200/2800T	-	L 1.5kW	R-S 3-F + SP, 10A
CRDV 200/200/1400/900T	0-Y-Y	-	R-S 3-F + SP, 10A
CRDV 200/200/2800/1400T	0-Y-YY 10A IP55	-	R-S 3-F + SP, 10A
CRDV 250/225/900T	-	L 0,4kW	R-S 3-F + SP, 10A
CRDV 250/225/1400T	-	L 0,75kW	R-S 3-F + SP, 10A
CRDV 250/225/2800T	-	L 2.2kW	R-S 3-F + SP, 10A
CRDV 250/225/1400/900T	0-Y-Y	-	R-S 3-F + SP, 10A
CRDV 250/225/2800/1400T	0-Y-YY 10A IP55	-	R-S 3-F + SP, 10A
CRDV 250/250/900T	-	L 0,4kW	R-S 3-F + SP, 10A
CRDV 250/250/1400T	-	L 0,75kW	R-S 3-F + SP, 10A
CRDV 250/250/1400/900T	0-Y-Y	-	R-S 3-F + SP, 10A
CRDV 315/280/900T	-	L 0,4kW	R-S 3-F + SP, 10A
CRDV 315/280/1400T	-	L 1.5kW	R-S 3-F + SP, 10A
CRDV 315/280/1400/900T	0-Y-Y	-	R-S 3-F + SP, 10A
CRDV 315/315/900T	-	L 0,75kW	R-S 3-F + SP, 10A
CRDV 315/315/1400T	-	L 2.2kW	R-S 3-F + SP, 10A
CRDV 315/315/1400/900T	0-Y-Y	-	R-S 3-F + SP, 10A

0-Y-Y	91040912	RVS-10	40025237
0-Y-YY 10A IP55	91040913	RVS-14	40025238
ERV-10	40025054	RVS-3	40025234
ERV-3	40025046	RVS-5	40025235
ERV-5	40025053	RVS-7	40025236
IRF-900	40015154	SC2-1-110L25	40025260
L 0.4kW	40016302	SC2-1-25L25	40025252
L 0.75kW	40016312	SC2-1-50L25	40025256
L 1.5kW	40016322	SC2-1-75L25	40025258
L 2.2kW	40016332	SC2A1-110L25	40025261
REB-10	40025055	SC2A1-25L25	40025253
REB-2.5 N	40025030	SC2A1-50L25	40025257
REB-2.5 NE	40025040	SC2A1-75L25	40025259
REB-5	40025051	TLR 25 DS	40025045
RMB-3.5	40025070	R-S 1-F + SP, 10A	91040907
RMB-8	40025080	R-S 1-F, 16A	91040907-01
RND-1	40025630	R-S 3-F + SP, 10A	91040908-01

